

Installation Instructions

Single Pole (One location)
SWITCH
15A-120/277V AC/CA

DI-000-E5601-02A

Cat. No. E5601

★ SAFER, FASTER, and EASIER

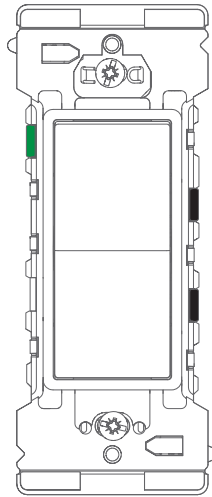

Leviton's Decora Edge Switch makes it safer, faster, and easier to install a new switch.

Colored levers easily identify where to connect each wire.

There are no exposed wires or metal parts after installation.

Built-in strip gauge.

An extra large plastic strap facilitates installation in large wall openings.

Designed for midway wallplates for extra coverage, or you can easily convert it to use with standard wallplates by removing the break-off tabs.

Built-in alignment feature to align other Decora Edge products in a multi-gang installation. (See page 12.)

1

★ Features

Terminates wire with a snap
The colored levers snap shut to terminate the wires.

Alignment Tab and Notch
Aligns devices for multi-gang installations.

Levers

Test Portals
Use to test device voltage.

Strip Gauge

Break-off Fins
Break off to install a standard size wallplate.

Strap

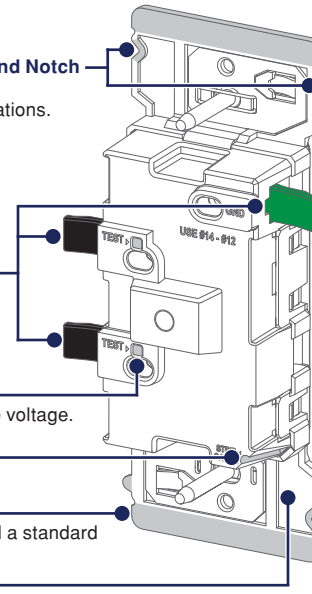

2

★ Lever Wiring Feature

The color-coded levers easily identify where to connect the wallbox wires to the switch.

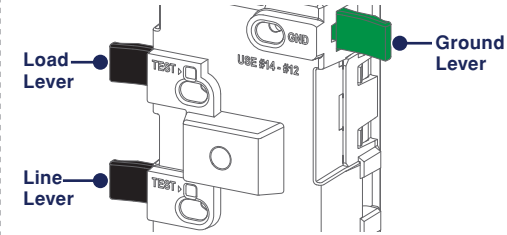

NOTE: Wire colors in your wallbox may be different from the lever colors. See "Identify Your Wires," on page 5 to make sure you insert the wires properly.

3

If you need help...

ONLINE
www.leviton.com/support

CHAT
www.leviton.com/contact

CALL
1-800-824-3005 (USA)
1-800-405-5320 (Canada)

🔧 Recommended Tools

Slotted/Phillips Screwdriver

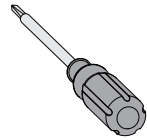

Wire Stripper



Needle Nose Pliers

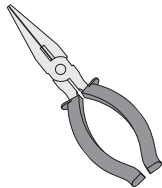

Voltage Tester

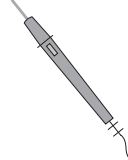

4

🔍 Identify Your Wires

WARNING: TO AVOID FIRE, SHOCK, OR DEATH, TURN OFF POWER at circuit breaker or fuse and test that power is OFF before wiring!

1. Remove the wallplate and disconnect the existing switch.
2. Restore power. Carefully, test the wires with a voltage tester to find the Line (hot) wire.
3. **Turn OFF the power at the circuit breaker or fuse.**
4. Label the wires, as shown below.

NOTES:

- **DO NOT** use copper-clad wires in this device.
- Neutral wires are typically white, and may be found in the wallbox. Neutral wires are not required to operate this device.
- Use with #12 AWG or #14 AWG solid or stranded wire only.
- Ground wires may be green.

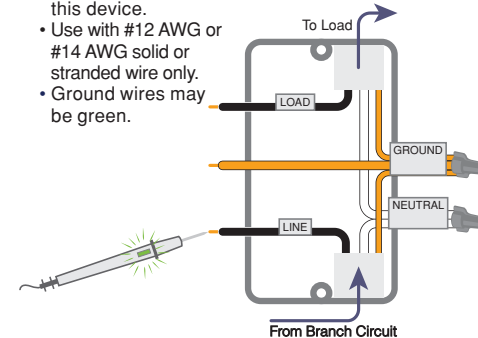

If your wallbox looks different, contact an electrician.

5

🔍 Preparing Wires

1. Make sure that the ends of the wires from the wallbox are straight (**cut if necessary**).



2. Strip each wire in the wallbox, as shown below.

Use Built-in Strip Gauge on the Switch

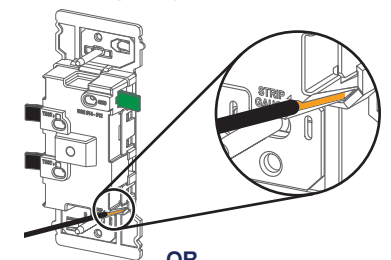

OR
Use Strip Gauge as shown below (measure bare wire here)

9/16 in.
(1.4 cm)

6

Single Pole Wiring

NOTE: Work on only one connection at a time.

1. Fully open lever.



2. Insert the proper wire per lever color into the wire hole. Make sure the wire is fully inserted and no bare wire is exposed.

NOTE: If using stranded wire twist wire before insertion.

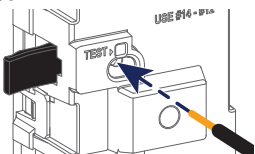

3. Fully close lever.

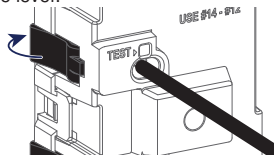

7

Single Pole Wiring (continued)

4. Connect the remaining wires as shown.

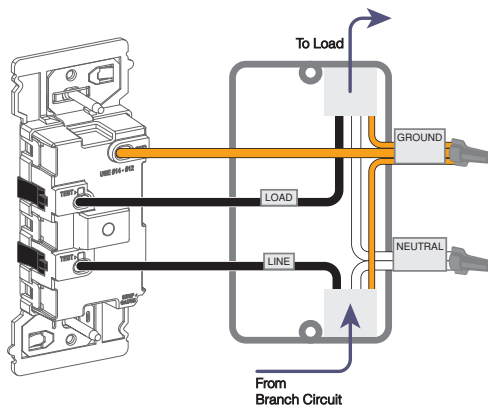

If you are unsure about these instructions, contact an electrician.

8

Test

1. Position all wires so that there is room in the wallbox for the device.
2. Partially screw the mounting screws into the wallbox's mounting holes.

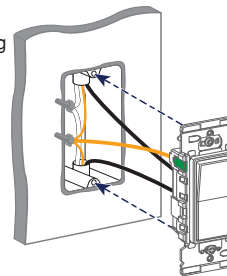

3. Restore power at the circuit breaker or fuse.
4. Press the switch to the ON position. If the Load turns ON, wiring is complete.

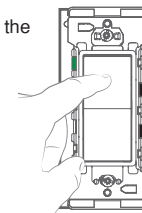

WARNING: Turn the power OFF at the breaker or fuse before you complete the installation.

5. To complete the installation, proceed to the next page.

If you are unsure about the installation process, contact Leviton Technical Support, or contact an electrician.

9

Wallplate Installation Preparation

The switch strap is designed for midway wallplates. If you want to use a standard size wallplate, carefully remove both break-off fins, as shown below.

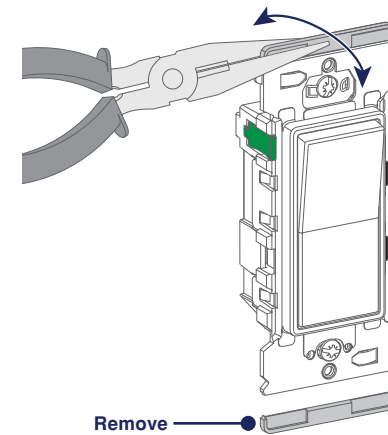

Remove

10

Single-Gang Box Installation

WARNING: Turn the power OFF at the circuit breaker before you tighten the screws.

1. Tighten the mounting screws into wallbox.

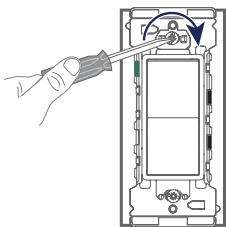

2. Install wallplate, and restore power.

11

Multi-Gang Box Installation

WARNING: Turn the power OFF at the circuit breaker before you tighten the screws.

1. To install the switch next to other Decora Edge devices, use the alignment feature to easily place each device next to each other in the multi-gang box.

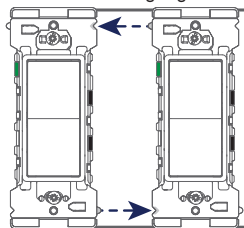

2. Tighten the mounting screws into wallbox.

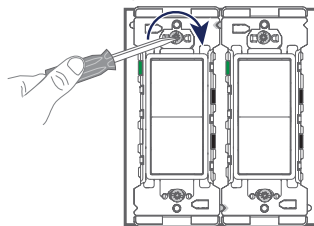

3. Install wallplate, and restore power.

12

For Additional Assistance

Scan this QR code for additional Decora Edge product information and to view the install video.



Visit leviton.com/support or contact Technical Services at 1-800-824-3005 for additional help.

13

Safety First

WARNINGS:

- TO AVOID FIRE SHOCK OR DEATH; TURN OFF POWER at circuit breaker or fuse when servicing, installing or removing device.
- This product is to be installed and/or used in accordance with electrical codes and regulations.
- If you are unsure about any part of these instructions, consult an electrician.

CAUTIONS:

- Use this device with **solid or stranded copper wire only**.
- **DO NOT** use this device with copper clad wire.
- To avoid damage to the product, **DO NOT** use disinfecting products, including foggers, sprays or other types of atomized cleaning agents.
- **DO NOT** spray liquid onto the product.
- To clean, use a damp cloth with mild soap.

PATENT STATEMENT

Patents covering this product, if any, can be found on Leviton.com/patents.

Limited 2 Year Warranty & Exclusions

For Leviton's limited product warranty, go to www.leviton.com. For a printed copy of the warranty, call 1-800-824-3005.

FOR CANADA ONLY

For warranty information and/or product returns, residents of Canada should contact Leviton in writing at **Leviton Manufacturing of Canada ULC** to the attention of the **Quality Assurance Department**, 165 Hymus Blvd, Pointe-Claire (Quebec), Canada H9R 1E9 or by telephone at 1 800 405-5320.

WEB VERSION